

wedi building solutions 2008



wedi waterproof tilebacker and shower systems -
The total solution for wet areas.

The Fine Line of Excellence



wedi GmbH Emsdetten, Germany

sales office west

Tel: 1.916.387.8500

Fax: 1.916.387.8300

E-Mail: info@gstallc.com

Web: www.wedicorp.com

sales office east & midwest

wedi Corporation

Tel: 1.770.366.6835

Fax: 1.770.783.8874

E-Mail: info@wedicorp.com

Web: www.wedicorp.com

wedi is a proud member of:



wedi GmbH is the world's leading producer of high quality ultra-lightweight ceramic tile underlayments and accessories. Located in Emsdetten, Germany wedi GmbH has been manufacturing wedi tile underlayment since 1983. The founder of the company, Helmut Wedi, was a master tile setter. Recognizing limitations in the materials then available in the tile industry Mr. Wedi set out to develop a system to overcome the shortcomings of traditional methods and materials. With a strong focus on real world application Mr. Wedi engineered the wedi system to provide the tile setter with a material capable of performing under the most difficult and diverse circumstances. The result was wedi tile underlayment.

Building Solutions

Helmut Wedi desired to produce a tile backerboard that would perform uncompromisingly in the field. In order for this to occur he knew wedi GmbH would have to develop methods of production unrivaled in the industry. Today wedi GmbH produces the building panel under the highest of industry standards. The level of quality control at the plant is so stringent the company has received an ISO 9001 rating, the first in their industry to receive such a certification. It is this dedication to excellence and the preservation of Mr. Wedi's vision that has resulted in an underlayment product unmatched in quality, applicability, and productive value. Furthermore, wedi produces complete shower systems including the wedi presloped fundo shower base, prefabricated curbs, recessed soap niches, shower seats and many more accessories. The wedi system enables the installer and builder to install a complete shower substrate ready for tile within hours backed by one system warranty

Stephan Wedi

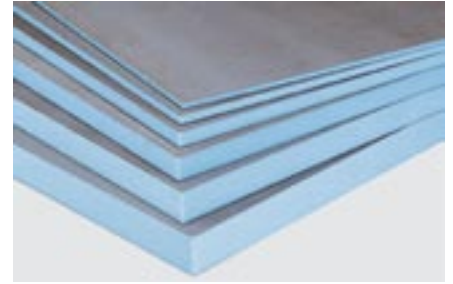

table of contents

3 the wedi system	12 product overview	21 sanbath
4 flooring: wood subfloor	13 product overview	22 benefits
5 flooring: concrete subfloor	14 product overview	23 ideas and visions
6 wood and metal framework/studs	15 sanoasa	24 specifications
7 drywall / solid backing	16 installation tips	25 technical data
8 tubs	17 steamrooms	26 architectural drawings
9 showers	18 ba balco	27 architectural drawings
10 fundo	19 exterior applications	
11 fundo installation	20 sanbath	

The wedi System

The wedi building panel is an ultra lightweight but heavy duty tile ready underlayment, weighing just over 8 pounds. The panels consist of three elements: the core foam, glass fiber mesh, and cementitious coating. The foam, extruded polystyrene Styrofoam, is the key element of the board. The foam forms a closed cell matrix, providing a dense, lightweight, 100% waterproof core. It is coated with a fiberglass mesh and polymer-modified mortar. The mesh adds to the strength and rigidity of the board and the coating functions as a superior bonding surface.



wedi building panel is produced under the highest of standards, resulting in an underlayment product unmatched in quality. The panels can be utilized in any area traditional tile backerboards are used. In addition, wedi board can be applied to areas where similar products would certainly fail to measure up such as showers, steam rooms, radius and curved walls. The wedi system can be put into place with astounding ease and speed, with the resulting installation holding up to the most rigid standards.



All you need is a few simple tools!

		wedi Tile Underlayment					
		Dimensions	Weight	Recommended Application			
		3' x 5' x 1/4"	8.07 lb	Floors Over Wood Or Concrete			
		3' x 5' x 1/2"	8.67 lb	Walls Direct to Stud Over Gypsum			
		2' x 8' x 5/8"	10.25 lb	Walls Direct to Stud			
		2' x 8' x 2"	15.21 lb	Walls Direct to Stud Over Gypsum			
		Tools and Material Needed For a succesful wedi Installation					
		Hammer or Screw Gun	Notch Trowel	Caulk Gun	wedi sealant or waterproof tape	Fasteners	Joint Tape
Walls	Direct to Studs/ over Drywall in Dry Area	X				X	X
	Direct to Studs/over Drywall in Wet Area	X		X	X	X	
	Over Gypsum in Dry Area	X	X			X	X
	Over Gypsum in Wet Area	X	X	X	X	X	
Floors	Over Concrete in Dry Area		X				X
	Over Concrete in Wet Area		X	X	X		
	Over Wood in Dry Area	X	X			X	X
	Over Wood in Wet Area	X	X	X	X	X	

All wedi Installations will require a utility knife, straight edge and level. Only wedi polyurethane sealant should be used.

wood subfloor

wedi building panel provides an excellent substrate for interior floors. It has passed the industry standard known as the Robinson Floor Test (ASTM 627), receiving a rating of heavy duty commercial use. When applied over a wooden substrate, wedi building panel acts as a waterproof membrane and creates a superior bonding surface for ceramic tile. In addition, the thermally insulating qualities of the panels make wedi board a superb candidate for installations incorporating floor-heating systems. The 1/4 inch (Item # 01-07-18/006) and 1/2 inch (Item # 01-07-17/064) materials can be used in flooring applications.

To apply wedi building panel over a wood subfloor the floor must be clean and free of debris. A modified mortar is applied to the floor with a 5/16 inch notch trowel to provide a ribbed bed. The wedi board is then laid into the mortar. All joints should be staggered so that no seam continues throughout the length of the floor. After the mortar has set, fasteners are applied at the rate of eight per square yard (sixteen per sheet). Tape all seams with alkali resistant fiberglass mesh tape or wedi polyurethane sealant (Item # 12-00-00/005) and commence tiling.



Simply spread polymer modified mortar over a clean wood subfloor.

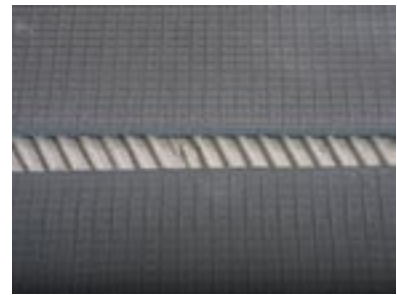

Apply the building panel by laying the panels into the mortar.



Fasten with wedi fasteners.



Tape all joints with fiberglass mesh tape or wedi waterproof tape or wedi polyurethane sealant and begin tiling!

wedi underlayment over wood subfloor

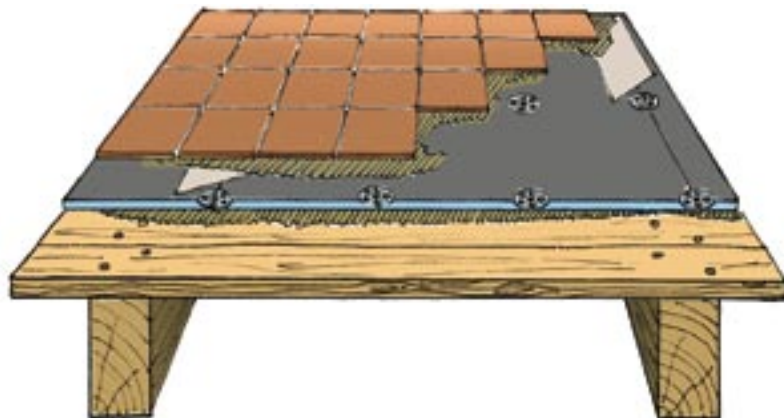

- wedi 1/4" and 1/2" is the recommended thicknesses for floors.
- Deflection of structural sub floor shall not exceed 1/360. (ASTM C627)
The subfloor must meet IRC/ICC Standards
- Wood subfloor should be a minimum of 5/8" exterior grade plywood or 3/4" OSB
- Joist spacing should not exceed 16 inch (.4m) o.c.
- 2" alkali resistant fiberglass mesh tape to be applied over all seams in dry areas. wedi waterproof polyurethane sealant or wedi sealing tape to be applied over all seams and fastener heads if a waterproof installation is required.

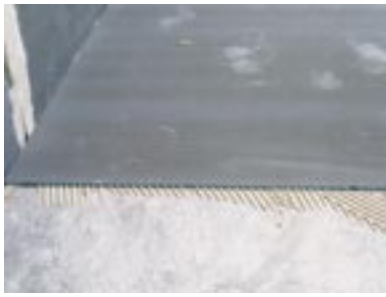

Make sure the concrete floor is fully cured and free of debris, oil or waxes.



The panels are installed with modified mortar.



Stagger all joints when laying wedi board on the floor.



Allow the mortar to set up, tape the seams with fiberglass mesh tape or use wedi polyurethane sealant and set your tile!

wedi underlayment over concrete

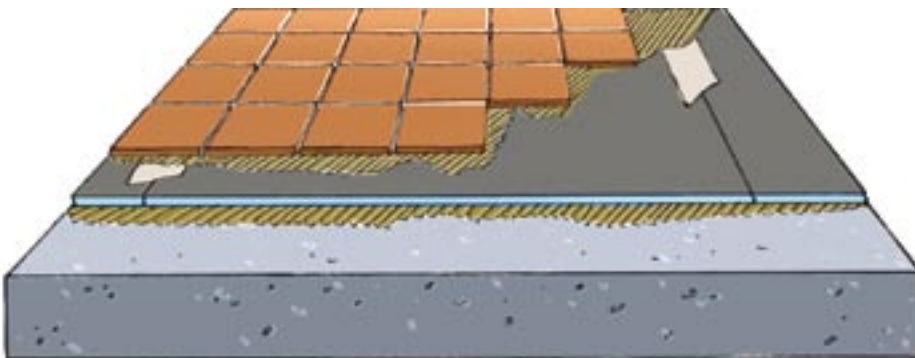

- wedi 1/4 or 1/2" inch is the recommended thicknesses for floors.
- Slab to be well cured and free of debris and waxy or oily films.
- Variation in slab not to exceed 1/4 inch in 10' span from required plane.
- 2" alkali resistant fiberglass mesh tape to be applied over all seams in dry areas. wedi waterproof polyurethane sealant or wedi sealing tape to be applied over all seams if a waterproof installation is required.

concrete sub floor

When installed over concrete, wedi building panel functions as a crack-isolation membrane. This is because cracks are not likely to transfer through the polystyrene core of the boards. The polystyrene foam acts as a moisture barrier, so when the seams are properly treated the system is 100 percent waterproof. The wedi panels are also used as a thermal insulator especially when installed underneath electric heating and floor warming systems. Heating cables and mats are typically embedded and encapsulated in a layer of tile adhesive mortar. Once cured, the installer sets tile in another, combed bed of tile adhesive mortar on top. Please contact heating system manufacturer for proper installation methods over backerboard and never install heating and floor warming systems underneath wedi systems to avoid heat being trapped.

Produced with less than a +/-1 mm variance of thickness, wedi building panel will provide a true surface on which to adhere floor tiles. wedi underlayments have passed the Robinson Floor Test (ASTM 627) with a heavy duty commercial use rating. To apply wedi board over concrete the floor must be clean and free of debris. Modified mortar is combed through with a 5/16 inch notch trowel to provide a ribbed bed. The wedi board is then laid into the mortar. All joints should be staggered so that no seam continues throughout the length of the floor. After the mortar has set, apply alkali resistant fiberglass mesh tape or wedi polyurethane sealant (Item # 12-00-00/005) to all seams and commence tiling.

wood and metal stud applications

Developed for absolute workability, the wedi system is easily applied directly to stud walls with only a few fasteners (Item # 12-00-00/008). After the panels are secured and the seams are taped, tiling may commence immediately. This means that a bare wall can be prepared, waterproofed and ready to accept tile in a fraction of the time required by traditional methods.

When applied to the wall, wedi building panel can be fixed either perpendicular or parallel to the framing; saving time and reducing the frequency of joints. Simply fasten the board into place with wedi screws or nails. All panel joints are butted tightly. The wedi fastener is set right into the joint where the washerhead presses both panel edges together and allows for the flush transition. If a waterproof installation is required, all joints and fastener points should be treated with wedi polyurethane sealant (Item # 12-00-00/005) or wedi waterproof sealing tape (Item # 09-51-10/311).

- 1/2 inch, 5/8 inch or 1 inch building panels are the recommended thicknesses for stud walls.
- Minimum wood stud depth 3 5/8 inch
- Minimum 20 gauge metal stud
- Stud spacing should not exceed 16 inch (.4m) o.c.
- 2" alkali resistant fiberglass mesh tape to be applied over all seams in dry areas. wedi waterproof polyurethane sealant or wedi sealing tape to be applied over all seams and fastener heads if a waterproof installation is required.



Using only a utility knife wedi building panel is effortlessly cut and



Positioning lightweight wedi building panel is



Fasten the wedi building panel into place with wedi screws or nails with washer



Apply 1 fastener per 1 foot on 16 o.c studs. On ceilings 16 o.c framework apply 1 fastener per every 6 inches



Treat all seams with a fiberglass reinforcement tape.



If a waterproof installation is required all joints and fastener points should be treated with wedi waterproof tape or wedi polyurethane sealant.

wedi underlayment directly to studs

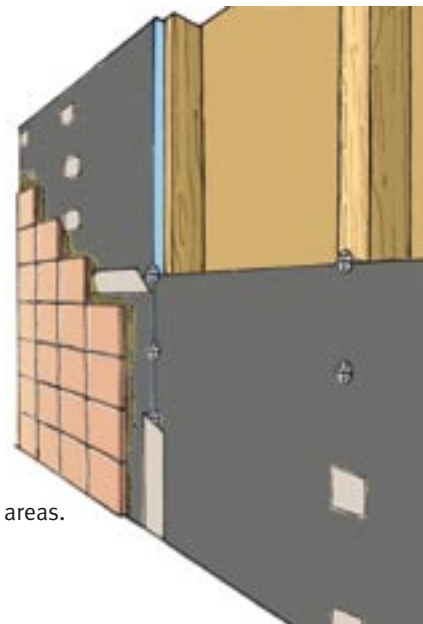

drywall/ solid backing



Trowel a bed of modified mortar over the wall.



Fasten the wedi building panel into place with wedi screws or nails with washerheads.



Cuts out are easily made using a utility knife or a jigsaw.



If a waterproof installation is needed all joints and anchor points should be treated with wedi waterproof tape or wedi polyurethane sealant.

wedi building panel is quickly and easily applied to drywall to provide an excellent substrate for ceramic tile. In wet areas wedi board is especially effective as it will function both as a moisture barrier and a superior bonding surface for ceramic tile.

To apply wedi building panel over drywall, simply trowel a bed of polymer modified mortar over the wall. Install the sheets of wedi building panel and apply fasteners into the studs behind the drywall. If a waterproof installation is required, all joints and fastener points should be treated with wedi polyurethane sealant (Item # 12-00-00/005) or wedi waterproof tape (Item # 09-51-10/311).

wedi underlayment over drywall

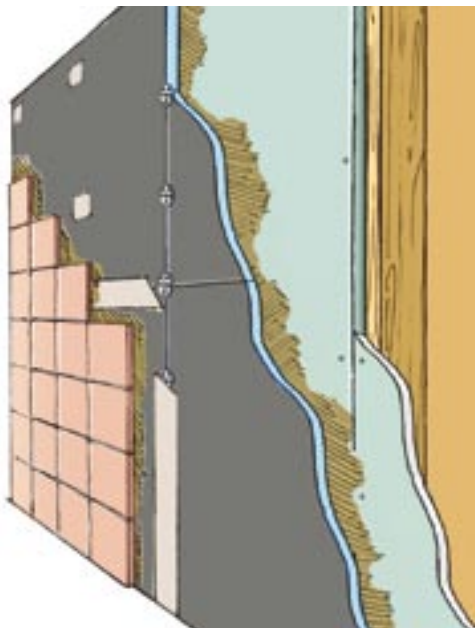

- 1/2 inch, 5/8 inch or 1 inch are the recommended thicknesses for walls.
- Minimum wood stud depth 3 5/8 inch
- Minimum 20 gauge metal stud
- Stud spacing should not exceed 16 inch (.4m) o.c.
- 2" alkali resistant fiberglass mesh tape to be applied over all seams and fastener heads in dry areas. wedi polyurethane sealant or wedi waterproof tape to be applied over all seams if a waterproof installation is required.

tubs

Because of its waterproof nature wedi building panel is the natural choice for use in wet areas. wedi panels can be applied directly to stud or over a gypsum product, to create a waterproof substrate for tile. wedi is used on the tub deck and backsplash to quickly put tub surrounds into place. The material can be easily scored and shaped to provide radius surfaces on tub skirts. The wedi building panels do not scratch a tub or fixtures during installation.

The dimensions of the wedi building panels make for quick installations in standard five foot tubs. Laid horizontally the sheet will span the full five foot length of the tub. At the head and foot of the tub the panel is secured to the wall vertically, where the three foot width provides the perfect dimensions for a tile ready tub surround. Notch the wedi panel for the lip of a tub to provide a plumb and even surface for tiled walls.



Measure and mark cuts and cutouts as usual.



On solid backing constructions use a modified mortar and wedi fasteners to apply wedi building panel.



Fasten wedi building panel into place with wedi screws or nails with washer-heads.



wedi polyurethane sealant or waterproof tape is applied on the seams and fastener points.

wedi underlayment in tub enclosures

- 1/2 inch, 5/8 inch, and 1 inch are the recommended thicknesses for walls.
- Minimum wood stud depth 3 5/8 inch.
- wedi joint sealant should be used where wedi panel meets the tub.
- Stud spacing should not exceed 16 inch on center.
- wedi waterproof polyurethane sealant or wedi sealing tape to be applied over all seams and fastener heads if a waterproof installation is required.

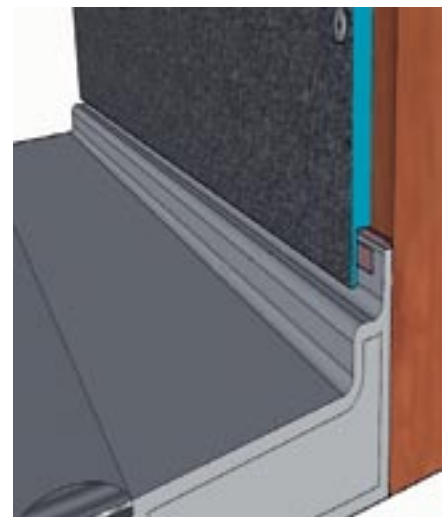

showers



wedi building panel is applied to the wall over gypsum or directly to stud.



Measure and mark cutouts as usual.



Using only a utility knife preparing the shower is a snap.



wedi polyurethane sealant or wedi waterproof tape is applied on the seams and fastener points.



The shower is complete and ready to be tiled.

Because wedi building panel is a waterproof tile backerboard, no additional moisture barrier is necessary when installing the product on shower walls. The board can be applied directly to wood or metal studs, over gypsum board, masonry walls, and existing tile. wedi building panels can be used with any kind of shower pan system including mud beds with pan liner or hot mopping and fiberglass pans. The most secure and ideal shower installation is to combine wedi building panels with the prefabricated wedi Fundo shower pan.

The recommended thickness for a shower wall application is 1/2 inch, 5/8 inch, or 1 inch. There are multiple thicknesses available to accommodate a wide variety of situations. The particular thickness used is dependent on the finish that the contractor wishes to create. If wedi building panel is applied over drywall, the 1/2 inch board will allow the tile trim pieces to cap the end of the wedi panel. The 5/8 inch wedi building panel can be applied directly to stud if the tile to be applied will have a flush or surface finish. The 1 inch wedi building panel can be applied directly to stud if a “floated” look is desired.

wedi underlayment in showers

- 1/2 inch, 5/8 inch, and 1 inch wedi are the recommended thicknesses for walls.
- Minimum wood stud depth 3-5/8 inch.
- Stud spacing should not exceed 16 inch on center.
- wedi waterproof polyurethane sealant or wedi sealing tape to be applied over all seams and fastener heads.

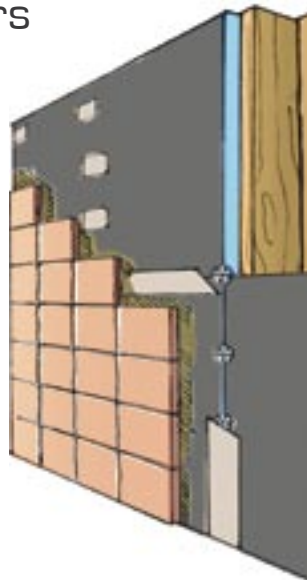

wedi fundo - the total solution

There are many ways to prepare and waterproof a shower for ceramic tile. Traditional methods are time consuming and difficult to do properly. Newer experimental methods commonly contain material flaws and suffer from a poor track record of successful installations. Failures in showers amount to millions of dollars lost to contractors, homeowners, and builders. Water damage leads to mold and mildew issues, which in turn increase warranty cost and the number of unsatisfied homeowners.

The wedi Fundo Shower Pan is a one step waterproofing system that offers a no risk, easy to install alternative. The wedi Fundo pan is composed of a closed cell extruded polystyrene foam, making it 100% waterproof. The pan is coated with a modified cement slurry and fiberglass mesh for strength and rigidity.

The wedi Fundo waterproof shower pan used in conjunction with the wedi building panels on the wall takes away multiple installation steps and materials used in conventional installations. It eliminates pre-sloping, pan liners, mud beds, waterproofing membranes and the weephole drain. It also eliminates risks related to conventional installations such as pan liner cracks, clogged weepholes and mold growth in mud beds. The prefabricated wedi shower pans help the installer to reduce the installation time of a shower base from 2-3 days to 30 minutes. All wedi shower substrate installations are tile ready the same day.

The wedi systems save 80% of the weight that conventional systems add to the building structure and offer thermal insulation value behind the tile. The Fundo shower pan can be easily cut to size or extended using pre-sloped extension panels to make it fit the actual shower size.

For over 25 years wedi GmbH has been producing waterproof materials for ceramic tile installations. wedi has become the worldwide market leader for waterproof foam core underlayments by following its philosophy of system solutions. wedi believes in complete systems that utilize cutting edge technology and the finest materials available to provide unparalleled quality.

wedi has developed shower accessories, curbs, niches, benches and seats to be used in conjunction with the wedi building panel and Fundo shower pan to offer the only complete tile ready shower waterproofing system on the market.

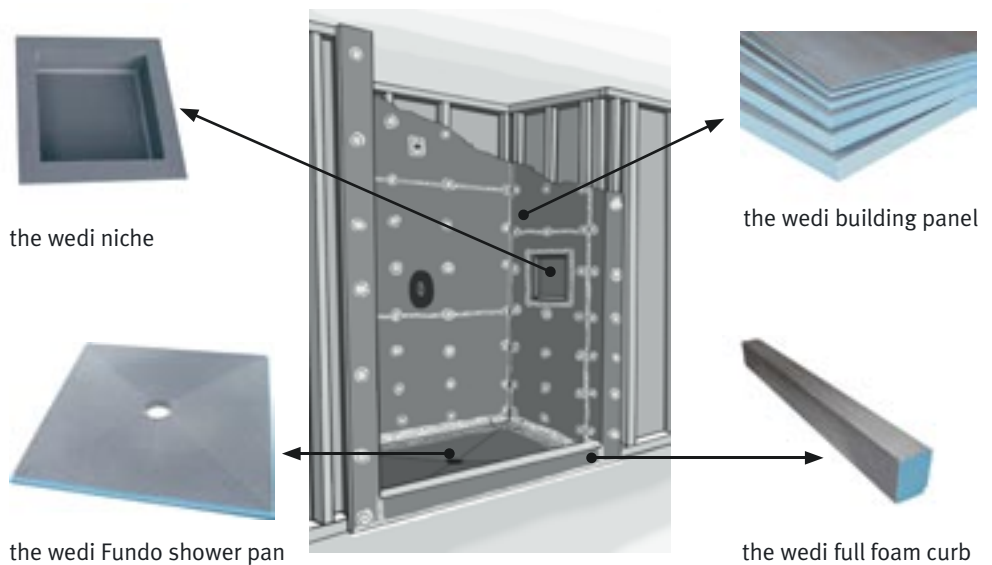

wedi shower pans can be easily cut to size. The prefabricated notch must be remanufactured to allow for a proper and interlocking installation of the wedi building panel 1/2".

fundo



1.



2.



3.



4.



5.



6.



7.



8.



9.



10.

1. Assemble the wedi drain to the wedi shower pan. Apply a 1/4" modified mortar bed on both the wooden or concrete subfloor and rear side of the Fundo pan.

2. Press the Fundo Pan firmly into the bed of mortar. Check the Fundo pan to ensure it is level.

3. Connect and seal the Fundo pan drain to the 2" drain pipe that is cut flush to the subfloor's top surface. Make sure the subdrain unit is securely mounted.

4 & 5. Apply a continuous 1/2" thick bead of wedi polyurethane sealant into the channel of the Fundo Shower Pan. Press the first wedi panel into the fresh sealant in the channel until you see part of the sealant squeezing out along the joint. Fasten the panel to the studs with wedi fasteners starting 1 ft above the shower pan. Make sure all following building panels are butted tightly together with a 1/4" thick bead of sealant applied on the edge of the panels to waterproof the seams. After the installation is complete, it is recommended to apply another bead of sealant on all joints especially on the Fundo shower pans perimeter joints, curb joints and all vertical joints to avoid any voids in the sealant. All fastener penetrations must be waterproofed on top of the washer-head using the wedi polyurethane sealant. The sealant on top of washers and all excessive joint sealant must be worked flat into the surface of the wedi products to achieve good adhesion and must be smoothed to offer a proper tile surface using a putty knife. After the sealant has set, you may begin to tile.

6. The wedi curbs are fixed and sealed to the Fundo shower pan channel and to wall panels using wedi polyurethane sealant. The curb is bonded to the subfloor using a 1/2" bed of modified mortar.

7. wedi niches are attached to the I6 o.c. studs using wedi fasteners and the wedi polyurethane sealant in between the joints.

8. The wedi shower system is ready for tile in a fraction of the time needed for traditional methods. wedi Fundo shower pans must be used with wedi building panels, wedi curbs and wedi polyurethane sealant only. Simply attach the drain, apply the pan, seal the joints and set your tile!

9. & 10. Fundo shower pans can be cut or extended using the presloped balco extension panels to virtually any size. The notch connections must be properly sealed with wedi polyurethane sealant.

wedi building panel 3 x 5 ft

Item #	dimension	unit
01-07-18/006	3 x 5 ft x 1/4"	SF sheet
01-07-17/064	3 x 5 ft x 1/2"	SF sheet

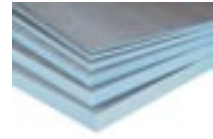

wedi building panel 2 x 4 & 2 x 8 ft

Item #	dimension	unit
01-00-00/004	2 x 4 ft. x 1/8" (60 x 125 cm)	SF sheet
01-07-16/316	3 x 5 ft x 5/8"	SF sheet
01-07-19/225	2 x 8 ft x 1" (250 x 60 cm)	SF sheet
01-00-00/040	2 x 8 ft x 1 1/2" (250 x 60 cm)	SF sheet
01-00-00/050	2 x 8 ft x 2" (250 x 60 cm)	SF sheet

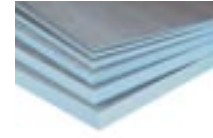

wedi BA balco presloped - presloped building panels for fundo shower pan extensions and more applications

Item #	dimension	unit
01-13-00/059	47 1/4" x 31 1/2"; 2" to 1 1/2" Can be used for Fundo Shower pan Extensions	sheet
01-13-00/058	31 1/2" x 47 1/2" to 3/4" Presloped building panel for exterior use on Patios/Balconies. Can be used in Combination with 01-13-00/059	sheet
01-13-00/010	31 1/2" x 47 1/4" x 3/8" for Exterior use. Flat building panel for exterior use on Patios/Balconies.	sheet

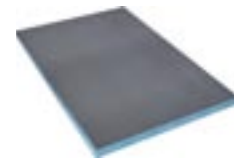

wedi installation accessories - fasteners / sealants

Item	Item #	dimension/application	unit
Washer Nail Combo	12-00-00/008	1 1/2" diameter washer with ringshank nail	100 pcs/box
Washers	12-00-00/006	1 1/4" dia. with tabs	100 pcs/box
Washers	12-00-00/007	1 1/4" dia. without tabs	100 pcs/box
Non Rust Screws	12-00-00/009	galvanized Wood screws, Length 1 5/8", Philips	100 pcs/box
Self Tapping Screws	12-00-00/010	Stainless steel tapping screws, Length 1 5/8, Phipps for Metal studs	100 pcs/box
wedi sealing Tape	09-51-10/311	Sealing Tape 5" x 32.8 ft	1 roll
wedi alkali resistant mesh tape	09-52-25/053	Self Adhesive Meshtape 5" x 82 ft	1 roll
wedi alkali resistant mesh tape	09-52-15/052	Self Adhesive Meshtape 24" x 164 ft	1 roll
wedi prefab corner tapes	09-51-30/000	Inside Corner Sealing Tape	1 piece
wedi joint sealant	12-00-00/005	polyurethane sealant	1 Cartridge
	12-00-00/005	polyurethane sealant	1 Box 24 Cartridges
	12-00-00/002	polyurethane sealant	1 Sausage

20 year limited product warranty for waterproof and flexible character of sealant used in wedi recommended applications.

wedi fundo shower - kits for framework applications

Item #	dimension	unit
07-37-83/509	36 x 36" *	piece
07-37-83/516	36 x 48" *	piece
07-37-83/511	48 x 48" *	piece
07-37-83/510	36 x 60" *	piece
07-37-83/524	36 x 72" * offset drain	piece
07-37-83/512	48 x 60" *	piece
07-37-83/513	48 x 72" *	piece



Wall height 80". All Fundo shower kits for framework applications consist of: wedi Fundo Pan, drain assembly, building panels, full foam curb, 16 x 16" niche, sealant and fasteners.

wedi fundo square

Item #	dimension	unit
07-37-83/507	Fundo square 36 x 36" incl. drain; 3 x 3 ft	piece
07-37-83/505	Fundo square 48 x 48" incl. drain; 4 x 4 ft	piece
07-37-83/518	Fundo square 60 x 60" incl. drain; 5 x 5 ft	piece

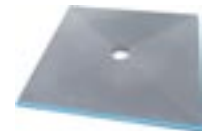

wedi fundo rectangle

Item #	dimension	unit
07-37-83/515	Fundo rectangle 36 x 48" incl. drain; 3 x 4 ft	piece
07-37-83/506	Fundo rectangle 36 x 60" incl. drain; 3 x 6 ft	piece
07-37-83/521	Fundo rect. 36 x 72" incl. drain offset 14"; 3 x 6 ft	piece
07-37-83/514	Fundo rectangle 48 x 60" incl. drain; 4 x 5 ft	piece
07-37-83/508	Fundo rectangle 48 x 72" incl. drain; 4 x 6 ft	piece
07-37-83/519	Fundo rectangle 60 x 72" incl. drain; 5 x 6 ft	piece
07-37-83/522	Fundo rectangle 48 x 84" incl. drain; 4 x 7 ft	piece
07-37-83/523	Fundo rectangle 60 x 84" incl. drain; 5 x 7 ft	piece

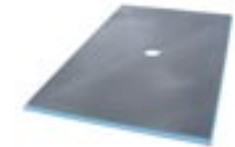

Wedi makes custom shape and size shower bases according to your specifications.

wedi shower curbs & accessories

Item #	dimension	unit
07-43-19/002	Curb full foam square edges 5 ft; 5 x 4 1/2"	piece
07-43-19/001	Curb full foam square edges 8 ft; 5 x 4 1/2"	piece
07-43-17/000	Curb over square edges 5 ft; 5 x 4 1/2"	piece
07-43-15/300	Niche square edges 16 x 16"	piece
07-43-15/400	Niche square edges 16 x 22"	piece
07-37-36/517	Shower Ramp 5 ft x 12" slope from 1 1/2" to 1/4"	piece
07-37-84/100	Rectangular Bench 32" long 32 x 16 x 20", sloped	piece
07-37-84/200	Triangle Seat 45° 32 x 16 x 20", sloped	piece
12-00-00/000	wedidrain cover custom colors *	piece
12-00-00/017	Drain Kit Standard PVC Drain	piece
12-00-00/018	Drain Kit Brass Drain	piece
12-00-00/024	Rubber Caulking Gasket for Cast Iron Pipe Connection	piece



Rectangular Bench



Triangle Seat

* available in different custom colors: satin brass 12-00-00/019, copper 12-00-00/020, brushed nickel 12-00-00/023, Round Stainless Steel Drain 12-00-00/025



Drainkit Standard PVC Drain



Shower Ramp



Curb Full Foam



Curb over square Edges



Niche



Strainer brass colored



Brass Drain

wedi fundo shower - kits

Item	Item #	dimension	unit
wedi fundo shower - kit "spiral" including shower pan, drain, partitions and polyurethane sealant plus joint reinforcement tape. Left or right entrance available.	07-37-50/000	(photo)	1
wedi fundo shower - kit "round" including shower pan, drain, partitions and polyurethane sealant plus joint reinforcement tape.	07-37-63/000	(photo)	1
wedi fundo shower - kit "pentagon" including shower pan, drain, partitions and polyurethane sealant plus joint reinforcement tape, profiles/tracks.	07-37-56/000	(photo)	1

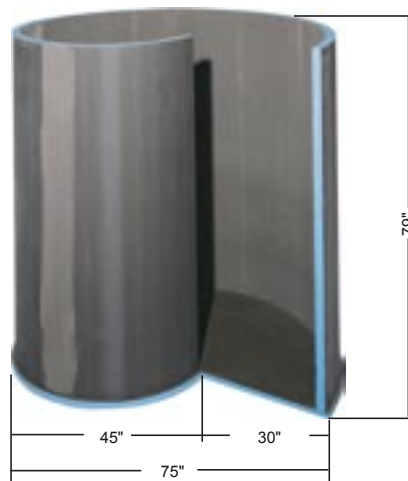

spiral



round

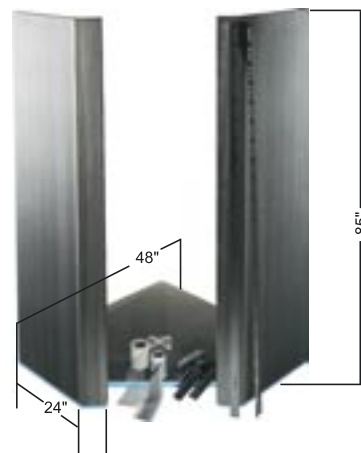

pentagon

wedi fundo shower doors

Item #	description
60-80-01/200	wedi round shower sliding glass door including mounting tracks and handle units
60-80-01/100	wedi round shower wall hanging glass door including mounting hinges and handle units
67-67-00/000	wedi steam room vapor tight stainless steel frame and safety glass door element including mounting hinges and handle units .Assembly with 2" thick wedi building panels (walls) only. wedi 2" building panel must surround the frame on sides and top part.

wedi sanoasa, relax benches

Item #	description	dimension
07-64-39/000	top section Onda	see diagram
07-64-40/000	base unit Onda width of top section: 28" width of base unit: 20"	see diagram

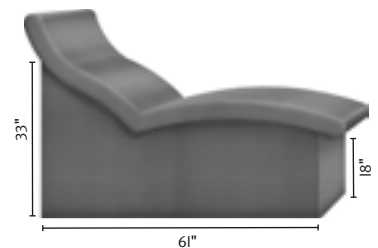

wedi sanoasa, Cillato rocking chaise

Item #	description	unit	dimension
07-64-46/000	Cillato rocking chaise	1	see diagram



wedi sanoasa, bench comodo (slope to front and slope to back)

Item #	description	dimension
07-64-38/000	bench Comodo, slope to front	see diagram
07-64-37/000	base unit Comodo	see diagram
07-64-36/000	bench Comodo, slope to back Length: 79"	see diagram

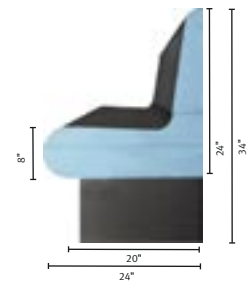

wedi sanoasa, bench forma

Item #	description	dimension
07-64-42/000	top section Forma	see diagram
07-64-43/000	base unit Forma Length: 79"	see diagram

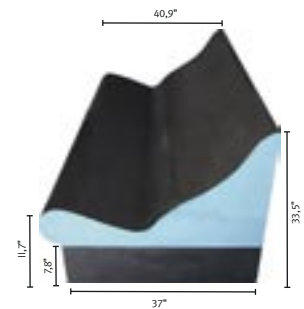

wedi sanoasa, bench piccolo (slope to front)

Item #	dimension	dimension
07-64-41/000	top section Piccolo	see diagram
07-64-41/500	base unit Piccolo Length: 79"	see diagram

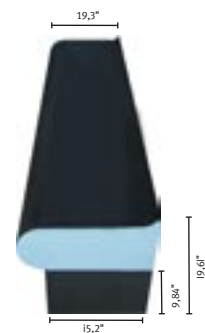

prefabricated

wedi spa and bathroom design products custom and standard solutions.

The wedi wellness line utilizes state of the art technology and European design elements to bring elegant yet functional style to your living space. wedi offers prefabricated and tile ready designs for steam rooms, showers, bathtubs and wash basins.

wedi's custom designs offer no limitation to what you can create with your own imagination. All systems can be fully equipped with the accessories needed to complete the installation; including water connections, armatures and glass door assemblies upon request. All that is needed is a concept drawing and wedi will design your project from planning to construction.

wedi has become the market leader for all aspects of commercial and residential waterproofing from shower pans to complete prefabricated bathroom and spa applications.

creating curves



Cut the wedi building panel using a utility knife and straight edge.



This way wave shape constructions can be produced.



For a small radius - cut out wedges from the building panel or ...



...cut the building panel using a hand - held circular saw ...



... and bend it into a curve.

stabilizing the curves



Fill in the insertions with mortar



Apply joint reinforcement tape to the insertions.

installing the fundo round and spiral



The wedi Fundo round and wedi Fundo spiral floor elements are equipped with a groove for positioning the partition elements.



Apply wedi joint sealant into the groove.



Place the partition element in the groove.



Join the individual elements together with wedi joint sealant using the tongue and groove point.



Apply wedi meshstape on inside and outside joints. The shower is tile ready.

installation of shower seats and benches using 2" wedi building panels



Cut bench parts from a wedi 2" building panel and consider a pitch for the horizontal seat area. Connect the parts using wedi joint sealant. For every 18" length, one vertical wedi 2" support is integrated.



Connect the top building panel with wedi joint sealant and smooth out excess using a putty knife.



Your bench is ready to be adhered against the wedi walls in your shower using tile adhesive. All joints are connected and waterproofed using wedi joint sealant. Using wedi 2" building panel you can create perfectly fitting corner seats and benches and install them on top of your shower floor.

steamrooms

wedi Steam Rooms "Sanoasa System"

for Commercial (Project) & Residential (Home) Use
Prefabricated Systems & Built on site.

wedi prefabricated assembly sets for steam rooms allow for installation without wooden or metal framework wedi offers standard and custom made system solutions.



1. Residential steam room (square size max 4 x 4 ft.)

Install wedi like in a regular shower application using 1/2" panels with sealant in between joints and covering the fastener applications. Where you have a "cold", exterior wall, install wedi 2" panels to ensure proper thermal insulation which minimizes the climate differential. When tiling commences, choose a dense tile or stone with low absorption. As setting material, you can choose standard or modified thinsets but you need to allow for curing time before you fill the joints using solid epoxy grout, recommended for steam room application by the manufacturer. It might be reasonable to use epoxy thinset to set tile to allow for a faster finish. Another benefit epoxy thinset offers is that it does not allow vapor to condensate between tile and wedi which will occur if standard thinsets and standard cement grouts are used.

2. Commercial steam room (square size > 4 x 4 ft.)

Install wedi like in a regular shower application using 2" wedi panels with wedi joint sealant in between and surface covering shiplap notch connections of adjoining panels. When tiling commences, choose a dense tile or stone with low absorption. As setting material, you can choose standard or modified thinsets but you need to allow for curing time before you fill the joints using solid epoxy grout, recommended for steam room application by the manufacturer. It might be reasonable to use epoxy thinset to set tile to allow for a faster finish. As an alternative, you might use wedi 1/2" panels applied to 16 o.c. framework. In this case, you want to apply an wedi recommended epoxy resin in two roll on coats over the entire wall and ceiling surface. Throw silica sand on the second fresh coat of resin to allow for thinset grip. Continue setting tile as shown above.



3. General tips for installing steam rooms:

- Build a slope into the ceiling so that condensed water can run down toward a wall without dripping (hot).
- Lead the steam supply copper pipe into the cabin in the lower third of the cabin wall height so that the steam can rise (steam rises upwards). Make sure the pressurized incoming steam is not lead into the cabin where people are sitting.
- Properly insulate the copper steam pipe so that the high temperature does not touch the wedi wall panel foam (wedi resists 175°F)
- Make sure that fresh air supply and exchange is given either through automated fans or an open space (1") between glass door and floor tile.

wedi ba balco sloped - sloped building panels

wedi building panels have been used in exterior applications for more than 25 years. The regular building panel, when used in combination with low absorbing adhesives, grout and tile added a lot of benefits. Now, wedi makes it even easier and introduces a product line with BA BALCO which can be installed with common exterior grade adhesives and grout. When tile adhesives, grout and tiles fail under extreme climate conditions, BA BALCO is still on duty. In case, its heavy duty coating allows for easy repairs without destruction of the underlayment system.



Lay the first BA Balco (Balco with slope from 3/4" to 1 1/2" (Item 01-13-00-058) onto the concrete substrate bonding it with exterior grade tile adhesive. On wooden surfaces, additional wedi fasteners (Item I2-00-00-008) are set at a rate of 1 per sqft. The Balco's should be notched to create a shiplap connection with adjoining Balco's. Continuously applied wedi joint sealant (Item I2-00-00-005) is used inside the connections.

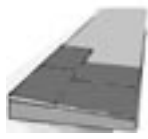

When the next Balco panel is installed closer to the building, (Balco with slope from 1 1/2" to 2" Item 01-13-00-059) the row of Balco's is laid in a staggered joint pattern and again connects to the first row using the shiplap notch/ joint sealing method as described in pic 1.



Once all areas are covered with BA Balco, all joints and possible fastener points must be waterproofed. wedi joint sealant or wedi sealing tape is applied on top of all joints (covering the joint 1" each side) and fastener points (covering the washer head 2" around it's center). A proper flashing is installed and the surface is tile ready! Cover untiled front edge of the installation against weather exposure with an appropriate profile. Please consult tile adhesive, grout and tile manufacturers for proper product specifications.

wedi ba balco - tough flat building panels for exterior use

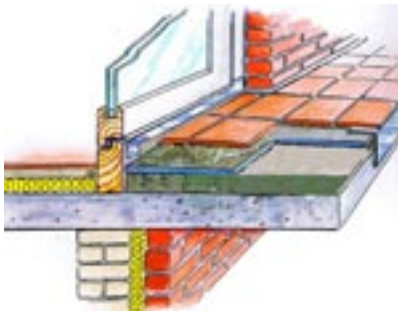

Over sloped surfaces, wedi Balco Flat Building Panel (Item 01-13-00-010) can be used. The installation is identical with the BA Balco sloped building panel's as shown above.



BA Balco systems can be installed over existing old tiled surfaces using adequate primers prior to installing BALCO in exterior grade thin set mortar. The old tiled surfaces must be stable. Old, loose tiles can be removed and are to be filled with thin set mortar to avoid hollow spots and voids underneath wedi BA BALCO.

wedi Building Panel & BA Balco must be installed in compliance with local building codes. wedi's physical properties and technical data should be considered and product should only be installed if in accordance with the existing or planned design of the building's moisture and insulation management systems fitting the local climatic environment. Installation on stable, sound, clean and dry substrates only. Protect the untiled application against weather exposure and keep dry when installing and thereafter until tile adhesive and grout are applied and fully cured per manufacturer's recommendations. wedi cannot be held liable for design or concept failures related to structures adjacent to the wedi system installation. Please contact wedi's Technical Services for regional solutions.

technical data ba balco

Properties and Test Methods Value

Shear Strength, ASTM C-273	34 psi(235 kPa)
Waterproofing	Waterproof, Absorption <1.5% DIN EN 12087
Capillarity	0
Compressive Strength, ASTM C-1621	36 psi ... (250 kPa)
Linear Coefficient of Thermal Expansion ASTM C-518	3.5x10 ⁻⁵ in/° F (6.3x10 ⁻⁵ in/in °C)
R-Value 75 F (25 C), ASTM C-518	0.23 Btu • in/hr • ft ² • ° F
Freeze & Thaw Cycle Stability per AC 159	4.3 hr • ft ² • F° /Btu/in
UV Resistance (Surface) per AC 71	Complies *(25 Cycles)
Linear Variation per AC 159	Complies (No Aging)
	Complies (< 0.7%)

more exterior applications

wedi building panels & BA BALCO - added value to your facade:

- Waterproof and vapor resistant.
- Freeze & Thaw cycle stable.
- Lightweight (does not wear on structure).
- Thermally insulating and Energy saving.

wedi building panels & BA BALCO offer superior bond strength, will not deteriorate in moist climates and add insulation in cold climates. Installation methods depend on the planned surface finishes, height of facade and must be compliant with local building codes.

Please contact wedi's technical Services for your best solution.



Honolulu, Hawaii, near coast.



Honolulu, Hawaii, near coast.



Waterproof wedi Benches in swimming pool



Pools for interior and exterior applications.

sanbath

In the bathroom revolution, the simple bathtub of yesterday has become the ultimate refuge for soothing the senses and promoting well-being.

In the context of bathroom furnishings, this trend has also been called "Bath Lifestyle" and offers everything you need. Creations of timeless beauty made from tile-ready wedi XPS foam systems. Sanbath is an impressive new wedi concept available in three ranges to bring distinction to any room.

wedi is specialized on shaping and manufacturing tile ready extruded polystyrene foam based elements such as round shower wall concepts, sinks, foot basins, benches and steam room concepts in any imaginable design (3rd Dimension included). wedi assists and supports in the planning and design of commercial and residential wellness and wet area tile concepts.

The benefits are:

Exact transformation of your design ideas into perfect tile ready elements.

Waterproof and vapor resistant underlayment systems for tile and stone secure the investment.

Insulating properties of wedi concepts and systems save Energy.

Lightweight properties ensure fast installation, handling and a total installation weight making it easy on structural construction.

All systems come with an installation manual and prefabricated part connections to ensure quick and safe installation.



wedi sanbath wave



wedi sanbath cube

note:

- The "Sanbath Flat" and "Sanbath Wave" wash basins are supplied with the relevant location holes prefabricated for the outlet siphon and fittings.
- The washstand "Sanbath Cube" is supplied with a watertight siphon prefitted as well as the location holes for associated fittings.
- The showers "Sanbath Cube" and "Sanbath Wave" are supplied with the Hans Grohe I-Box prefitted as well as the associated pipe work to the showerhead outlet.
- The drain and overflow fittings are pre-fitted to the bath tubs "Sanbath Cube" and "Sanbath Wave".
- Delivery time: approx. 5 weeks after receipt of the order.

wash basin wedi sanbath wave

Item #	item	dimension	unit
07-36-03/000	wash basin Sanbath Wave with mounting	see diagram	1 item
07-36-01/000	bath tub Sanbath Wave	see diagram	1 item
07-36-02/000	shower Sanbath Wave	see diagram	1 item

bath tub wedi sanbath cube

Item #	item	dimension	unit
07-36-07/000	bath tub Sanbath Cube	see diagram	1 item
07-36-06/000	washstand Sanbath Cube	see diagram	1 item
07-36-05/000	shower Sanbath Cube	see diagram	1 item

wash basin wedi sanbath flat

Item #	item	dimension	unit
07-36-04/000	wash basin Sanbath Flat with mounting	see diagram	1 item
07-36-04/500	wash basin Sanbath Flat without mounting	see diagram	1 item

Bath tub wedi Sanbath Wave

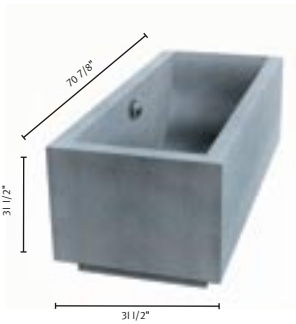

Shower wedi Sanbath Wave



Wash basin wedi Sanbath Wave



Bath tub wedi Sanbath Cube

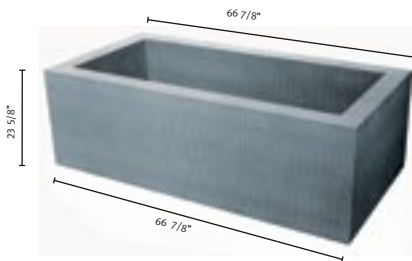

Shower wedi Sanbath Cube

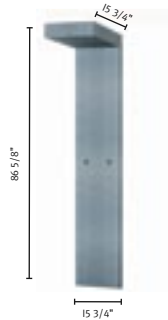

Washstand wedi Sanbath Cube



Wash basin wedi Sanbath Flat

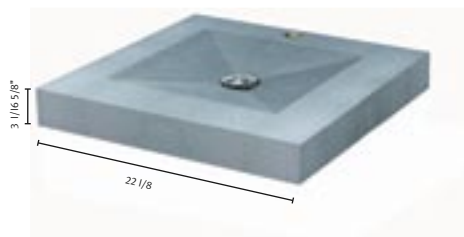

benefits for...

...Architects

- Simple specification - Single source Manufacturer for complete shower system.
- Controllable results - Complete product line requiring only basic installation methods/steps.
- Design flexibility - Wide product range offers solutions to accomplish most unlimited design possibilities.
- Green aspects - wedi is insulating, light, non-hazardous, non-polluting and produced with ozone layer friendly extrusion promoters.
- Can be recycled.

...Builder/Developer

- Cheap insurance - wedi's sustainable solutions do not fail and last a life time.
- Save on costly repairs.
- Reduced liability - wedi is 100% waterproof and will never mold or mildew.
- Expedited construction schedule - Reduced time frames with tile ready installed showers in 2-3 hours, safe from bottom to top.
- Steam rated - wedi is your preferred choice for both commercial and residential steam rooms.
- Marketing - Increased home owner benefit to market. Environmentally friendly and protects against mold & mildew.
- Ultimate dependability - wedi systems are the market leading tile underlayment in Europe based on a 25 year proven Quality Leader track record - with availability and field support worldwide.
- Improved sight conditions and cleanliness on site - wedi systems cut on site causing no or little dust and debris and is non-hazardous.
- Schedule relief - wedi's speed of installation brings you ahead of your schedule.
- Crack protection - wedi's soft foam core minimizes crack transfer, especially when used on concrete slabs.
- Easy for supervisors - Success & quality control by inspecting the installation on its surfaces prior to tile application.

...Installer/Contractor

- Extremely lightweight, but stable - wedi makes it easy to stock projects and make it easy on your back.
- Complete System - wedi offers all components needed in showers prior to setting tile.
- Increased Capabilities - wedi's ease of fabrication, using simple tools and flexibility increase your possibilities when designing custom showers.
- Reduced Travel Time - Fast shower installation without the burden of curing times.
- Reduced Labor - Extreme labor time savings due to ease of installation. Waterproofing built in.
- Basic Skills required - Perfect machine made products eliminate to complicated conventional shower set up and add quality.
- Basic Tools required - wedi cuts easily with a utility knife and straightedge. Simply score & Snap.
- Reduced Clean Up - wedi systems cause little or no debris when installed.
- Reduced Callback Issues - Due to wedi's better crack protection and internal waterproof character.
- Increased Capacity - Where one crew installs 2 conventional showers in a workweek, wedi allows for 8-9 showers.
- Tile-ready and Custom made.
- Heavy Duty Use - wedi on floors, walls, and ceilings is rated for heavy duty commercial use.
- High Load and Bond - wedi provides excellent truly flat surfaces for setting tile due to its highly modified cementitious bond coating.
- Increased capacity - Ability to handle more work with the same number of people.
- High Compressive Strength - Once tile is installed on wedi, it's rated for heavy duty use.
- Excellent bonding surface.
- Green Building Product.



the total solution for preparing and protecting substrate in wet area tile works.



specifications

Composition & Materials

The product consists of a Styrofoam* Brand Foam insulation core, coated on both sides with a fiberglass mesh and polymer-modified mortar.

Sizes

Available in 1/8 inch (3mm) 1/4 inch (6 mm), 1/2 inch (12.7 mm), 5/8 inch (16 mm), 3/4 inch (20 mm) 1 inch (25.4 mm), 1 1/2 inch (40 mm), 2 inch (50 mm) Sheet sizes are 3 x 5 feet 2 x 4 feet and 2 x 8 feet

Finish

The building panel surfaces are a polymer-modified mortar, with a texture provided by the fiberglass mesh.

Color

The panels are medium gray on both faces. The exposed edges are light blue. wedi foam based systems are not to be used as finish materials.

Shape

The panels are rectangular, but may be cut to any shape.

Limitations

Product should be adequately supported when installed over framing or other appropriate substrates. It should not be used over vinyl flooring and it is not intended to be used as a structural member.

wedi building panel is the ultimate lightweight ceramic tile backer board, designed to provide a waterproof substrate for interior applications. It is suitable for use as a backer board for ceramic tile on interior floors and walls. wedi building panel is also suitable for countertops, but should not be used where extremely hot items will be placed directly on the ceramic tile surfaces.

The 1/4 inch and 1/2 are designed for flooring applications where they provide waterproofing, insulating and superior tile bond properties. The 1/2 inch, 5/8 inch and 1 inch products are designed for wall and countertop applications.

wedi building panel is odorless and chemically inert. Some harsh chemicals or organic solvents may cause damage to the cementitious coating or the foam core. The product has no food value to attract plant or animal life or the growth of microorganisms.

Due to the properties of the extrusion process that produces closed cell foam and the hydrophobic nature of polystyrene, the foam core of wedi building panel has exceptional resistance to water and water vapor. wedi board is waterproof according to ASTM and ANSI test methods, and is part of a waterproof installation when seams and fastener heads are properly treated.

Availability

wedi building panel is manufactured in Germany and is being distributed through an extensive network of distributors throughout the U.S. It is available in several sizes, as listed in the chart on page 3. Your local wedi distributor will be able to provide additional information about availability of products listed. Product cost and installation information is available by calling your local wedi distributor or directly from wedi corp.

Technical Services and

wedi corp. is eager to assist in the proper use of wedi building panel and to answer questions relating to the product. For assistance please contact Technical Services USA at Phone 770-366-6835 or E-Mail: info@wedcorp.com. wedi offers in house installation work shops and is a member and provider of the AIA continuing education program (CES) and also a proud associate member of the NTCA (National Tile Contractors Association) and TCNA (Tile Council of North America).

*Trademark of the Dow Chemical Company

technical data

American Society for Testing and Measuring (ASTM)

- ASTM C 203-92
- ASTM C 273-94
- ASTM C 518-91
- ASTM C 627-93
- ASTM D 1621-94
- ASTM D 1623-78
- ASTM D 4068-95
- ASTM E 84-95

American National Standards Institute (ANSI)

- ANSI A 118.10-1993

Uniform Building Code (UBC)

- 26-3

Approvals:

- City of New York, MEA 912-52-SM
- ICC ESR 1773 (for USA and Canada)
- LA RR 25585 City of Los Angeles
- DIN EN ISO 9001
- Fundo Shower Pan: IAPMO File No.4953 (for USA and Canada)
- BBA (British Board of Agrément)

Approvals for wedi building panel and Fundo Shower Systems

ICC, Meets ASTM + ANSI Standards, UBC, TCNA handbook recognized for wall, floor, countertop, etc. applications, IAPMO/UPC File No.4953

Properties & Test Methods Value

Shear Strength

- ASTM C-273.....34 psi (235 kPa)

Flexural Strength

- ASTM C-203.....212 psi (1460 kPa)

Tensile Strength

- ASTM D-1623.....33 psi (225 kPa)

Compressive Strength

- ASTM D-1621.....36 psi (250 kPa)

Linear Coefficient of Thermal Expansion

3,5 x 10⁻⁵ in/in °F (6.3x10⁻⁵ in/in °C)

Thermal Conductivity

75°F (25°C) - ASTM C- 518.....0.23 Bbtu in/hr F

R-Value

75°F (25°) - ASTM C-518.....4.3hr ft2 F/Btu/in

Robinson Floor Test

- ASTM C627 Heavy duty commercial use

Width x Length x Thickness	Weight
3' x 5' 1/4"	8.07 lb.
3' x 5' 1/2"	8.67 lb.
3' x 5' 5/8"	8.97 lb.
2' x 8' 1/8"	10.25 lb.

Waterproof

wedi building panel has been tested and demonstrated to be waterproof using ANSI A 118-10-1193. With proper treatment of seams and fastener heads, the installed product forms a moisture barrier suitable for most applications without an additional waterproof membrane.

Environmental Considerations/Green Building

Wedi building panel is CFC-free. The product is inert. Wedi products are produced without leaving any waste in production, can be recycled and will not contribute to water pollution. The high insulating properties of wedi products support energy conservation. Lightweight shipping helps reduce fuel consumption. The product is non-hazardous and user friendly in fabrication and use.

Fire Protection

All installations incorporating wedi building panels should provide adequate fire protection. Coverings that provide a 15-minute thermal barrier, such as ceramic tile, are regarded as acceptable in most applications. The product passed the Room Fire Test. In the surface building test it had a flame spread index of 20 or less and a smoke developed index of 360-415.

Physical/Chemical Properties

wedi building panel is lightweight and easy to handle, cut and install. wedi building panels have met ASTM C 627, commonly known as the Robinson Floor Test, requirements for residential and commercial use. Test reports are available.

Building codes

Current information on building panel code requirements and product compliance may be obtained from a wedi technical sales specialists. Installation must comply with the requirements of all applicable local, state and national code jurisdictions.

drawings

OVER ENGINEERED JOIST (Tongue - and - Groove Subfloor)

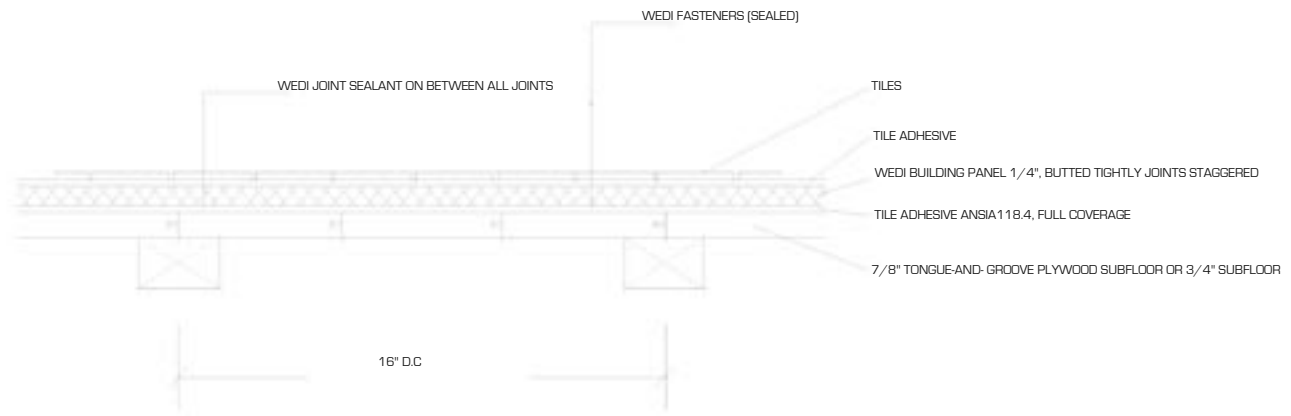

INTERIOR FLOORS Radiant Heat on Concrete Cementitious - Coated Foam Backer Board

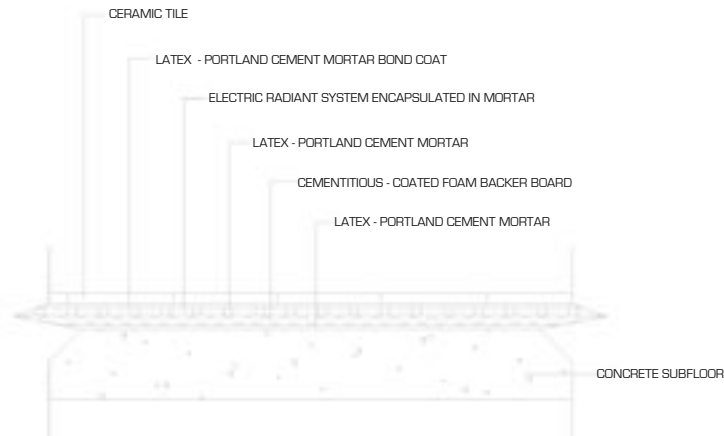

INTERIOR FLOORS Concrete Subfloor Cementitious - Coated Foam Backer Board

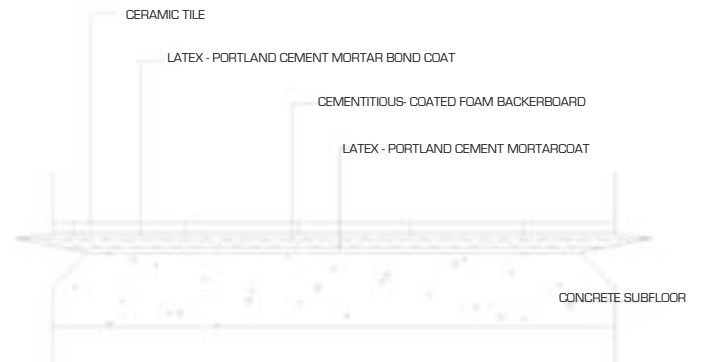

INTERIOR FLOORS Over conventional Joist

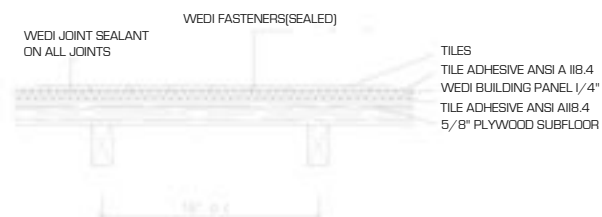

drawings

INTERIOR WALLS

Countertops Wood Base
Cementitious - Coated Foam Backer Board

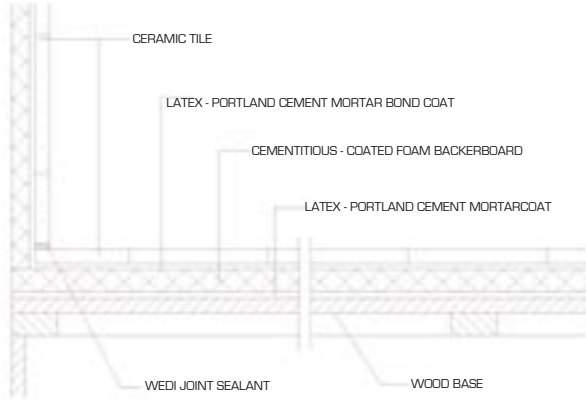

INTERIOR WALLS

Bathtub / Shower Receptor

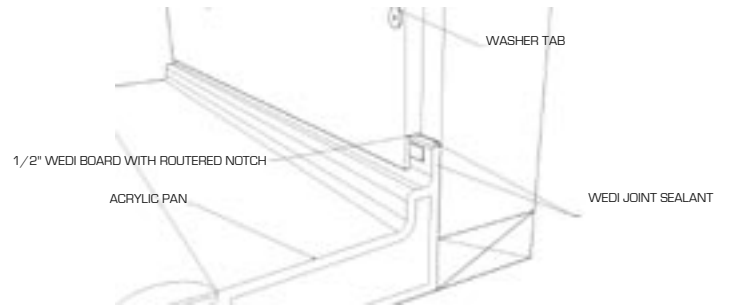

INTERIOR WALLS

Shower Seat

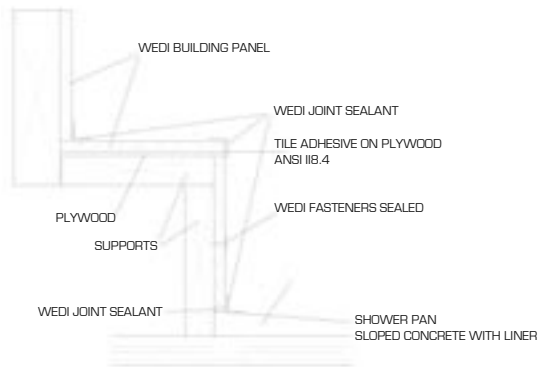

WEDER FUNDO PRE-SLOPED 100% WATERPROOF SHOWER PAN

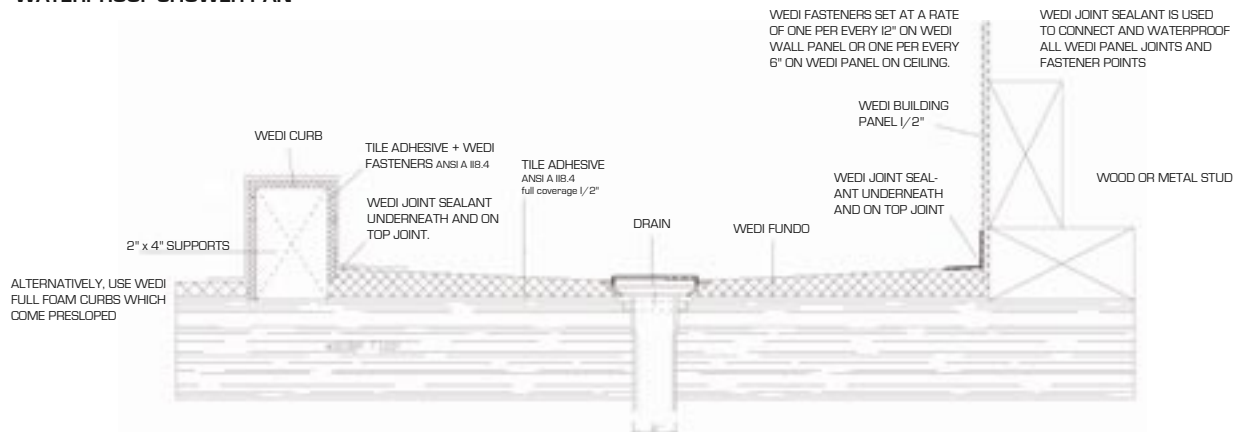

wedi® corp.



Your local wedi Distributor

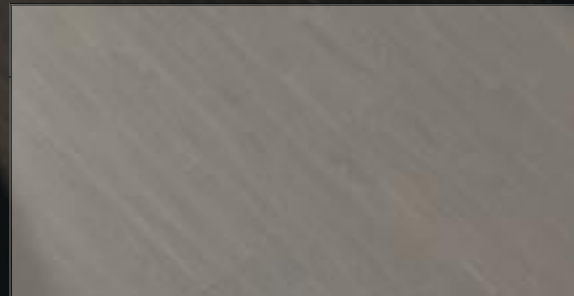

wedi sales office west

Tel: 1.916.387.8500
Fax: 1.916.387.8300
E-Mail: info@wedincorp.com
Web: www.wedincorp.com

wedi sales office east/midwest

Tel: 1.770.366.6835
Fax: 1.770.783.8874
E-Mail: info@wedincorp.com
Web: www.wedincorp.com